

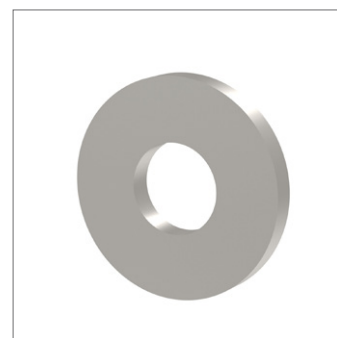

Flat Washers Form C

A4 stainless

Flat Washers

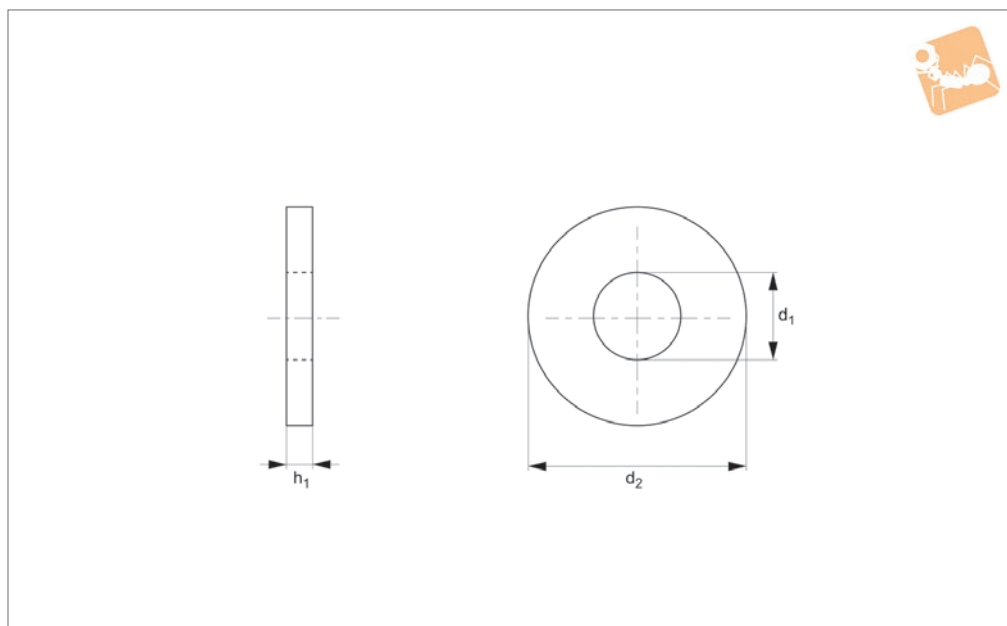

P0332.A4

FLAT WASHERS

Material

Stainless steel (A4).

Technical Notes

To DIN 125 C, BS4320C.

Order No.	For thread	d_1	d_2	h	Material
P0332.040-A4	M 4	4.3	10	0.8	A4 s/s
P0332.050-A4	M 5	5.3	12.5	1.0	A4 s/s
P0332.060-A4	M 6	6.4	14	1.6	A4 s/s
P0332.070-A4	M 7	7.4	16	1.6	A4 s/s
P0332.080-A4	M 8	8.4	21	1.6	A4 s/s
P0332.100-A4	M10	10.5	24	2.0	A4 s/s
P0332.120-A4	M12	13.0	28	2.5	A4 s/s
P0332.140-A4	M14	15.0	30	2.5	A4 s/s
P0332.160-A4	M16	17.0	34	3.0	A4 s/s
P0332.180-A4	M18	19.0	37	3.0	A4 s/s
P0332.200-A4	M20	21.0	39	3.0	A4 s/s
P0332.220-A4	M22	23.0	44	3.0	A4 s/s
P0332.240-A4	M24	25.0	50	4.0	A4 s/s
P0332.270-A4	M27	28.0	56	4.0	A4 s/s
P0332.300-A4	M30	31.0	60	4.0	A4 s/s