

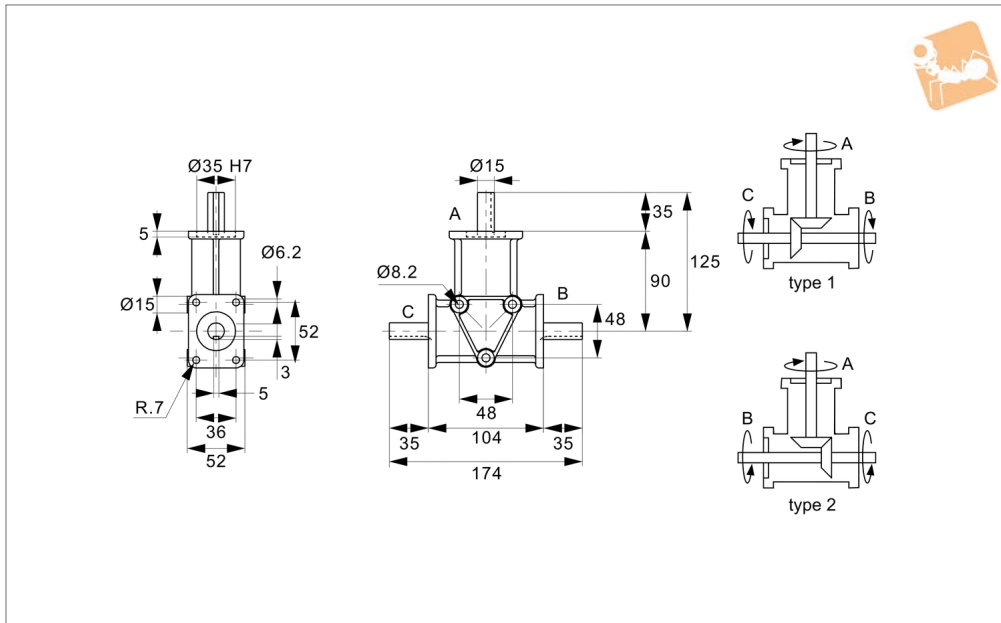

# Right Angle Drives - 3 Shafts

Ø15 shafts

## Right Angle Gear Boxes



**R2307**

RIGHT ANGLE GEAR BOXES

**Material**

Lightweight aluminium alloy housing.  
Case-hardened steel gears and shafts.

**Technical Notes**

Normally used as speed reducers.  
Shaft A is the input shaft. Optimum performance based on max. 1400 rpm input.  
Provides on average 10,000 hours trouble-

free life.

Where ratio geared units are used as speed increasers the optimum input speed is 750 rpm for 1:2 ratios.

Very low operating noise levels. Temperature range is -20° to +80°.  
Max. radial loading :41 Kg.  
Max. axial loading: 20 Kg.

Angular alignment: 15' to 30' of arc.

**Tips**

See technical pages for gear box selection guide, based on motor rating, gearing ratio, load type and expected hourly usage hours.

Order No.	Shaft dia. tol. f7	Ratio	Input shaft A kW max.	Output shaft B Nm max.	Output shaft C Nm max.	Weight kg
R2307.1	15	1:1	1.29	4.4	4.4	1.2
R2307.2	15	2:1	0.66	2.25	2.25	1.2