

L1900.CB

LONG LINEAR RAILS

Material

Steel (100Cr6) rollers with 2RS seals (splashproof). 2Z seals (for dust protection) available on request.

Lubricated for life.

Technical Notes

To choose the correct replacement roller

select either the plain, concentric or eccentric roller with the correct seal type.

| Order No. | For rail type | For rail size | Roller type | d ₁ | d ₂ | d ₃ | d ₄ | d ₅ | h ₁ | w ₁ | w ₂ |
|-----------------|---------------|---------------|-------------|----------------|----------------|----------------|----------------|----------------|----------------|----------------|----------------|
| L1918.CBC18-2RS | T and U | 18 | Concentric | 14.0 | 12.4 | - | 6 | M 4 | - | 4 | 1.6 |
| L1918.CBE18-2RS | T and U | 18 | Eccentric | 14.0 | 12.4 | - | 6 | M 4 | 0.4 | 4 | 1.6 |
| L1918.CBR18-2RS | T and U | 18 | Roller only | 14.0 | 12.4 | 5 | - | - | - | 4 | 1.6 |
| L1928.CBC28-2RS | T and U | 28 | Concentric | 22.4 | 19.2 | - | 10 | M 5 | - | 7 | 2.4 |
| L1928.CBE28-2RS | T and U | 28 | Eccentric | 22.4 | 19.2 | - | 10 | M 5 | 0.5 | 7 | 2.4 |
| L1928.CBR28-2RS | T and U | 28 | Roller only | 22.4 | 19.2 | 7 | - | - | - | 7 | 2.4 |
| L1943.CBC43-2RS | T and U | 43 | Concentric | 35.0 | 30.8 | - | 12 | M 6 | - | 11 | 5.0 |
| L1943.CBE43-2RS | T and U | 43 | Eccentric | 35.0 | 30.8 | - | 12 | M 6 | 0.8 | 11 | 5.0 |
| L1943.CBR43-2RS | T and U | 43 | Roller only | 35.0 | 30.8 | 10 | - | - | - | 11 | 5.0 |

| Order No. | w ₃ | w ₄ | w ₅ | w ₆ | A/F | Dyn. load C ₀ kN | Static load C kN |
|-----------------|----------------|----------------|----------------|----------------|-----|--------------------------------|---------------------|
| L1918.CBC18-2RS | 7.3 | 5 | 1.8 | 1.5 | 8 | 0.4 | 0.8 |
| L1918.CBE18-2RS | 7.3 | 5 | 1.8 | 1.5 | 8 | 0.4 | 0.8 |
| L1918.CBR18-2RS | - | - | - | - | - | 0.4 | 0.8 |
| L1928.CBC28-2RS | 13.0 | 8 | 3.8 | 2.2 | 13 | 1.1 | 2.5 |
| L1928.CBE28-2RS | 13.0 | 8 | 3.8 | 2.2 | 13 | 1.1 | 2.5 |
| L1928.CBR28-2RS | - | - | - | - | - | 1.1 | 2.5 |
| L1943.CBC43-2RS | 18.0 | 11 | 4.3 | 2.5 | 15 | 2.7 | 6.0 |
| L1943.CBE43-2RS | 18.0 | 11 | 4.3 | 2.5 | 15 | 2.7 | 6.0 |
| L1943.CBR43-2RS | - | - | - | - | - | 2.7 | 6.0 |



The compact rail systems are unique. They have many major advantages over other rail systems.

Easy and cost-effective to set up

The rails are easy to set up and can adjust for some misalignment of the structure on which it is being used. The compact rail system achieves this by using a master (T type) rail, and a slave (U type) rail. This allows the sliders in the T rail to remain fixed in place but allows lateral movement of the sliders in the U rail to adapt to any misalignment and avoid any issues of stiction.

Slave (U) rails have flat, parallel raceways that allow free lateral movement of the sliders. This flexibility can mean a large saving in the machining of the structure surface making it a very cost-effective solution.



Fast, smooth and quiet

The unique eccentric roller allows easy preload adjustment for smooth running. Very high speeds allowed, very quiet operation.

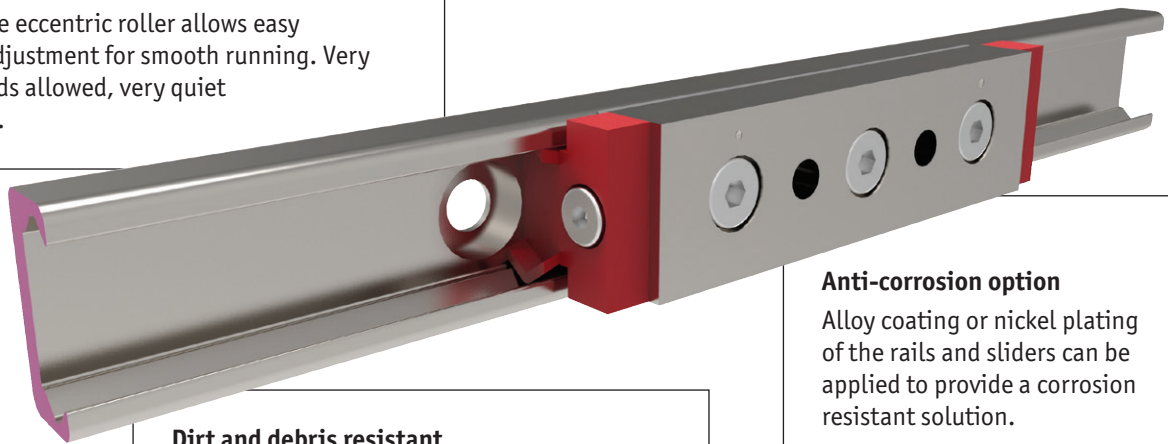

Anti-corrosion option

Alloy coating or nickel plating of the rails and sliders can be applied to provide a corrosion resistant solution.

Dirt and debris resistant

The internal raceways are resistant to dirt and debris, larger roller bearings with seals and wipers are used (compared to small ball bearings on other systems).

Unlimited rail lengths

Rails can be easily joined together for unlimited rail lengths, and extra hole needs to be machined at the joint area. The rails need to be selected so they are "matched" and a joining tool needs to be used to align the rails.

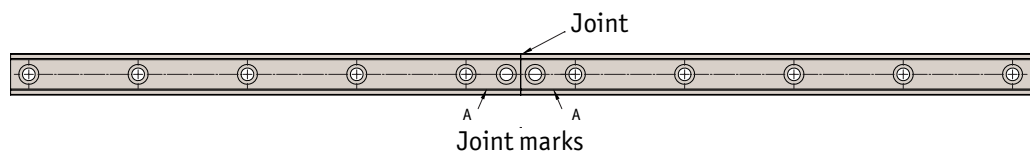



Compact Rails

Specifications and applications

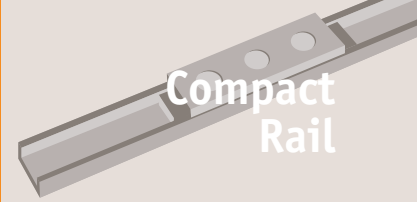

Compact Rail

Specifications

- Maximum speed 9 m/s.
- Maximum acceleration 20 m/s².
- Maximum unjoined rail length 3600 mm.
- 4 rail sizes – 18, 28, 35 and 43.
- Three rail types – T rail, U rail and K rail.
- Rail lengths from 160mm upwards.
- Rail raceways hardened and ground.
- Accuracy 0,15mm over 3,5 metres.
- Maximum radial load per slider is 15,000 N.
- Temperature range -30°C to +120°C.
- Roller bearings seals either 2Z (dust proof) or 2RS (splash proof), lubricated for life.
- Roller bearings from 100Cr6.
- Easy adjustment of preload.
- Three slider body types.
- Rails can be joined together, please contact our Technical Department for details.
- Special anti-corrosion coatings and finishes on request.

Applications



Special purpose & packaging machines

Precision positioning systems
handling units
robotic systems • cutting machines



Seating

Sliding seats
disability ramps
seat extensions



Safety guarding

Extending protective systems
sliding gates
automatic pick & place



Sliding doors & windows

Internal sliding doors
gates • roof lights
display cases



Photography & lighting

Sliding tracks
positioning of lights
shielding systems



Medical technology

X-ray equipment
dental chairs
bed extensions



Food, drink & pharmaceuticals

Food handling conveyors
pharmaceutical factories
stainless display equipment



Transport (naval)

Sliding hatches
pull-out storage



Transport (rail)

Seat adjustment
sliding doors
battery removal units



Transport (automotive)

Ambulance sliding systems
fire fighting vehicles
sliding panels

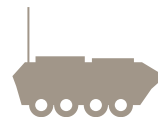

Transport (military)

Sliding seats
protective hatches
stretcher extensions



Rail sizes

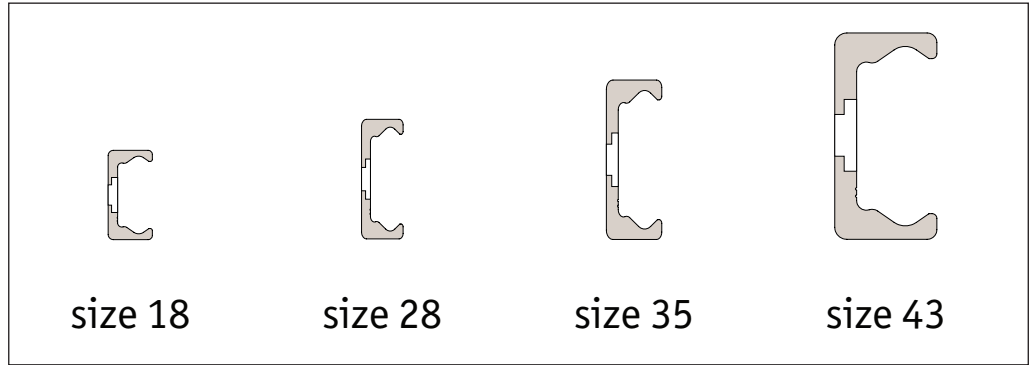

Rail types

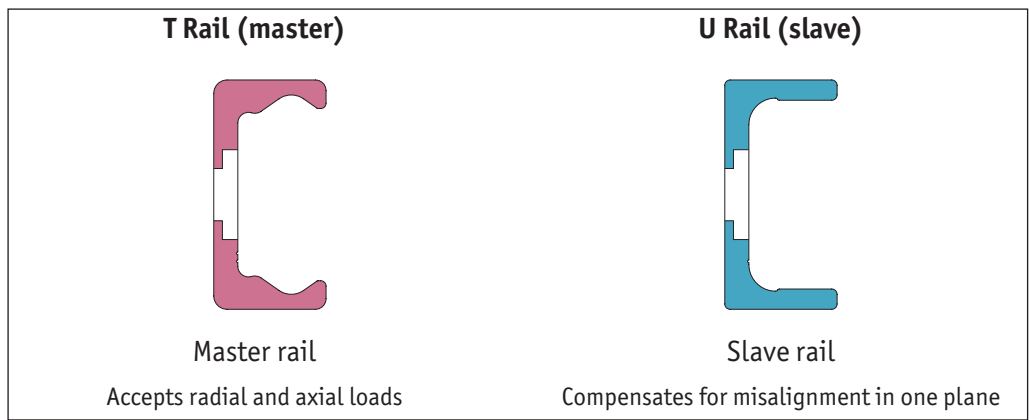

Sliders

| | |
|--|---|
| <p>Solid body, front mount - Type CL Solid steel, zinc plated body with removable end wipers side seals, fixing in top face</p> |  |
| <p>Solid body, front mount - Type CS Narrow body, solid steel zinc plated with removable end wipers no side seals, fixing on top face</p> |  |
| <p>Solid body, side mount - Type CR Solid steel, zinc plated body with removable end wipers side seals, fixing in side of body</p> |  |

Compact Rail from Automation Components

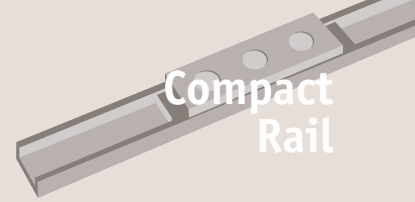

Orientation of rails

The radial load that the sliders can take is significantly higher than the axial load, so where possible the rails should be set up with the sliders taking the loads in this plane.

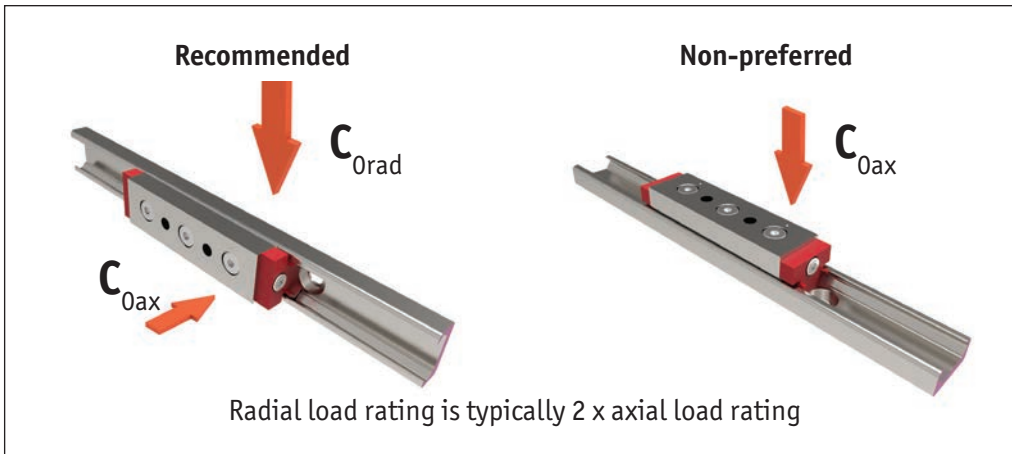

One of the key benefits of the compact rail system is that it compensates for misalignment in the structure. This often results in a major cost saving when compared to the use of other guideways which have to be very accurately installed.

The compact rail system achieves this by using a master (T type) rail, and a slave (U type) rail. This allows the slides in the T rail to remain fixed in place but allows lateral movement of the sliders in the U rail to adapt to any misalignment and avoid any issues of stiction.

U rails have flat, parallel raceways that allow free lateral movement of the sliders. The maximum lateral movement for each size is shown in later tables.

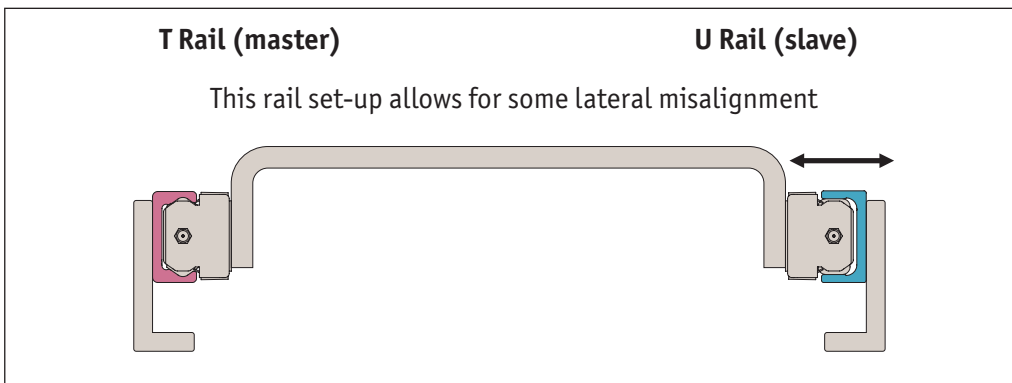

Using flat rails

It is acceptable (but not the preferred method), to use rails as below but the alignment accuracy needed is slightly greater and in this set-up only T type rails can be used.

In this case the axial load figure C_{0ax} should be used in any calculations (which is considerably less than the radial load figure C_{0rad}).

