

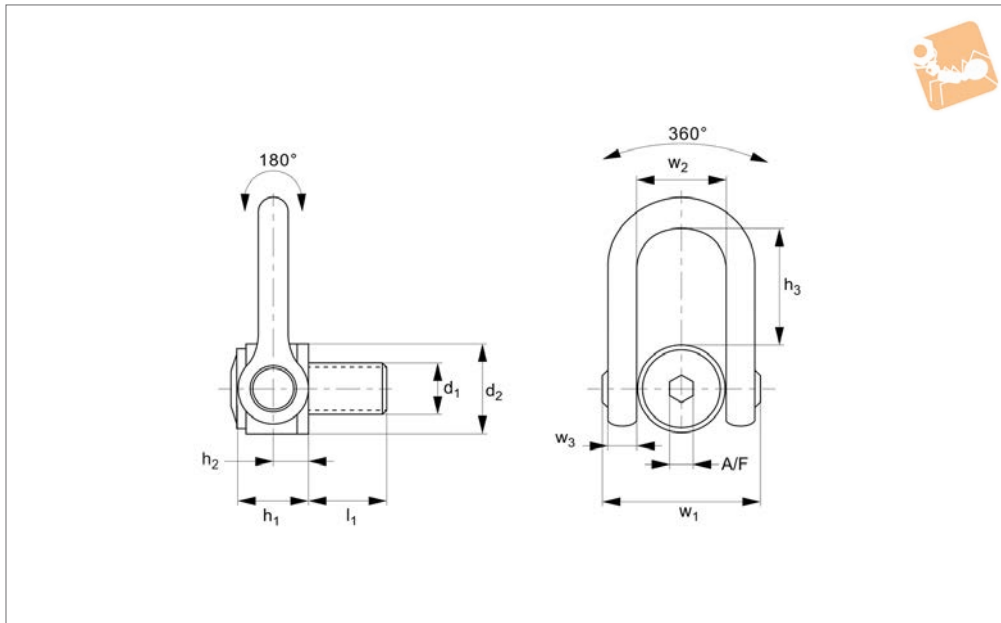

Mega Double Swivel Shackles Male

Lifting Pins,
Lifting Bolts &



P4011

LIFTING PINS, LIFTING BOLTS & SWING BOLTS

Material

High tensile steel, strength class >8.
Supplied with CE certificate.

Technical Notes

For use in temperatures from -20°C to +200°C. Can be used in lower or higher temperatures, but this affects the load rating - please ask for more information.
Please refer to our technical information pages when specifying and/or using.

Tips

Double articulation allows perfect alignment with the sling if the part rotates during the lift.
With „automatic“ position recovery system for best orientation to sling direction.
Tighten by hex. key or spanner.

Important Notes

The thread diameter and depth must be appropriate to the material into which it will be installed:

Steel (min. ST37) - 1 x thread dia.
Cast iron - 1.25 x thread dia.
Aluminium - 2 x thread dia.
Other light metals - 2.5 x thread dia.
Tolerance of female thread to be 6H (metric) or UNC-2B (inch).
Please refer to the safety documentation before using this part.
Supplied with certificate and operating instructions.

Order No.	Load tons (t) max.	d ₁ tol. 6g (tol. 2A)	l	h ₁	h ₂	h ₃	w ₁	d ₂	w ₂	w ₃	A/F	Safety factor	Torque to Nm (ft-lb)	Weight kg
P4011.M064	33.0	M 64x6	100	127	64	186	278	140	143	69	36	4	600	42.0
P4011.M072	35.0	M 72x6	110	127	64	186	278	140	143	69	36	4	700	43.0
P4011.M073	35.0	M 72x4	110	127	64	186	278	140	143	69	36	4	700	43.0
P4011.M080	40.0	M 80x6	120	127	64	186	278	140	143	69	36	4	800	44.5
P4011.M090	45.0	M 90x6	135	127	64	186	278	140	143	69	36	4	900	46.5
P4011.M100	60.0	M100x6	150	127	64	186	278	140	143	69	36	4	1000	49.0
P4011.I275	(75.000)	(UNC 2"3/4-4)	105	127	64	186	278	140	143	69	36	4	(520)	42.5
P4011.I300	(80.000)	(UNC 3"-4)	115	127	64	186	278	140	143	69	36	4	(520)	43.0
P4011.I325	(90.000)	(UNC 3"1/4-4)	125	127	64	186	278	140	143	69	36	4	(590)	44.5
P4011.I350	(95.000)	(UNC 3"1/2-4)	135	127	64	186	278	140	143	69	36	4	(665)	46.0
P4011.I375	(100.000)	(UNC 3"3/4-4)	145	127	64	186	278	140	143	69	36	4	(740)	47.0
P4011.I400	(110.000)	(UNC 4"-4)	150	127	64	186	278	140	143	69	36	4	(740)	49.0



Single swivel

Threads M8 – M48
Loads 0,3 tons to 15 tons



Double swivel

Threads M4 – M100
Loads 0,05 tons to 50 tons



Triple swivel

Threads M8 – M56
Loads 0,3 tons to 22 tons

Introduction to swivel lifting rings and Lifting Bolts (P4002-P4055)

Our swivel lifting rings fully comply with the EC directive 2006/42/EC. They are CE marked and are supplied with a Certificate of Conformity. There is a 100% check on anti-cracking, a proof load test of 2.5 x load limit and a safety factor of 5 on most parts. Each ring is individually marked to ensure full product traceability.

The Swivel Lifting Rings come in three main forms – depending on the number of axis required to swivel. The most popular type is the double swivel rings.

Other Standard Lifting Bolts

Standard lifting bolts (to DIN 580 and DIN 582) (P4040-P4048)

These are CE marked and are available with male or female threads in either steel or stainless steel (A4 AISI 316). They are meant only for linear loading of the bolts at a maximum angle of 45° from the thread. They are not meant for loads that might swivel.

These are supplied with a generic CE Certificate of Conformity stating that the parts have been manufactured to the relevant DIN standard and therefore suitable for lifting.

High-tensile lifting bolts (P4054-P4055)

The High-tensile lifting bolts are similar to the standard lifting bolts but are rated at higher loads and can lift loads at up to 90° from the thread. They are not meant for loads that might swivel.

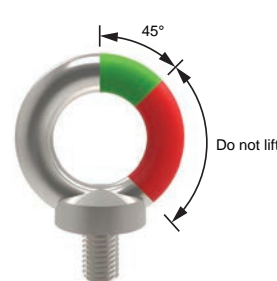

Standard lifting bolts
DIN 580 & DIN 582
P4040-P4048



Hi-tensile lifting bolts
P4054-P4055

Swivel lifting rings operating instructions.

Please follow these instructions carefully.

- Ensure all lifting bolts are CE marked.
- Ensure they are handled by qualified personnel.
- Refer to the operating instructions particularly with regards to product selection, any possibility of the load swivelling, the effect of lifting angles on the load capacity (see relevant tables), etc.
- Never allow any personnel underneath a suspended load.
- Always heed the load rating of the lifting bolt.
- Always perform a visual inspection of the lifting rings prior to use. Checking for any damage to thread and/or swivelling system. Check for wear or corrosion, signs of stress or bending. Check CE mark and load rating.
- Ensure a yearly full service inspection is performed.
- Always ensure the full bottom face of the lifting bolts is in contact with a smooth, square surface.
- Ensure bolt is tightened to the correct torque.
- Ensure full and unrestricted movement of the lifting ring in all directions.
- Before each lift ensure the correct orientation of the shackle in the lift direction.
- Avoid using our standard steel lifting rings in corrosive environments eg sandy, chemical, acid, moisture etc. In this case consider using our stainless steel lifting rings.

- Note the thread length requirements:
 - 1 x thread diameter for steel (ST37 min.).
 - 1.25 x thread diameter for cast iron.
 - 2 x thread diameter for aluminium.
 - 2.5 x thread diameter for other light metals.
 - If fixing into low resistance material it is better to allow for a bigger diameter thread to compensate for the lower material resistance.

Note: The full thread must be engaged. Longer thread lengths can be supplied on request or a bolt and washer/nut combination can be used.





Product Overview

Swivel Lifting Rings

Lifting Bolts



Temperature extremes

- 40°C to -20°C Load rating reduces by 20%.
- +200°C to +300°C Load rating reduces by 10%.
- +300°C to +400°C Load rating reduces by 25%.

Rugged

For harsh environments we recommend the use of our stainless steel lifting rings.

Product marking

Compliant with 2006/42/EC, and with individual date of manufacture and batch number.

Complies with 2006/42/CE



Lifting angles

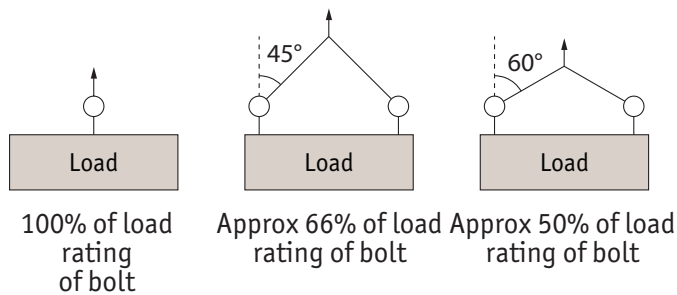

For full information on lifting arrangements see technical pages

Steel and Stainless steel (316) versions



Steel



Stainless (316L)

P4020

Threads M8 – M30
Loads 0,3 tons to 3 tons.



P4022

Threads M30 – M45
Loads 3,5 tons to 6 tons.



Installation Information

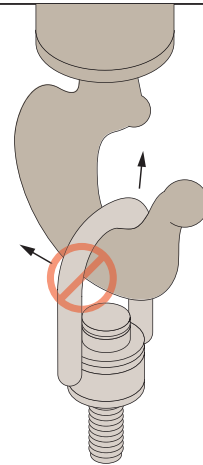

Never use an oversized hook or other lifting device which will pry or tend to open the "U" shaped bar on center pull hoist rings.

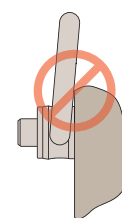

After installation, check the hoist ring to be sure it swivels and pivots freely in all directions. **The side of the ring must not contact anything.**

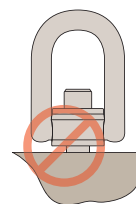

Always ensure full thread engagement when installing hoist rings. Also ensure face is flush.

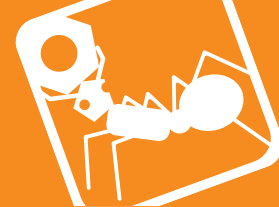

P4002 Male



P4004 Female



LIFTING PINS, LIFTING BOLTS & SWING BOLTS

Lifting type									$\alpha \text{ max.} = 60^\circ$ 		$\alpha \text{ max.} = 60^\circ$ 	
	1	2	1	2	2	2	4	4				
No. of rings	1	2	1	2	2	2	4	4				
Lifting angle	0°	0°	90°	90°	45°	60°	45°	60°				
Part no.	Thread											
P4002.M008 & P4004.M008	M 8		0,30 tons	0,60 tons	0,30 tons	0,60 tons	0,40 tons	0,30 tons	0,60 tons	0,30 tons		
P4002.M010 & P4004.M010	M10		0,60 tons	1,20 tons	0,60 tons	1,20 tons	0,80 tons	0,60 tons	1,30 tons	0,60 tons		
P4002.M012 & P4004.M012	M12		1,00 tons	2,00 tons	1,00 tons	2,00 tons	1,40 tons	1,00 tons	2,10 tons	1,00 tons		
P4002.M016 & P4004.M016	M16		1,60 tons	3,20 tons	1,60 tons	3,20 tons	2,20 tons	1,60 tons	3,40 tons	1,60 tons		
P4002.M020 & P4004.M020	M20		2,50 tons	5,00 tons	2,50 tons	5,00 tons	3,50 tons	2,50 tons	5,30 tons	2,50 tons		
P4002.M024 & P4004.M024	M24		4,00 tons	8,00 tons	4,00 tons	8,00 tons	5,60 tons	4,00 tons	8,40 tons	4,00 tons		
P4002.M030 & P4004.M030	M30		6,30 tons	12,60 tons	6,30 tons	12,60 tons	8,80 tons	6,30 tons	13,20 tons	6,30 tons		
P4002.M036 & P4004.M036	M36		10,00 tons	20,00 tons	10,00 tons	20,00 tons	14,00 tons	10,00 tons	21,00 tons	10,00 tons		
P4002.M042	M42		12,50 tons	25,00 tons	12,50 tons	25,00 tons	17,50 tons	12,50 tons	26,30 tons	12,50 tons		
P4002.M048	M48		15,00 tons	30,00 tons	15,00 tons	30,00 tons	21,00 tons	15,00 tons	31,50 tons	15,00 tons		

Technical Information

Double Swivel Lifting Rings

Lifting Bolts

P4005 Male



P4006 Female



Lifting type									α max. = 60°		α max. = 60°	
	1	2	1	2	2	2	4	4				
No. of rings	1	2	1	2	2	2	4	4				
Lifting angle	0°	0°	90°	90°	45°	60°	45°	60°				
Part no.	Thread											
P4005.M004	M 4	0,050 tons	0,100 tons	0,050 tons	0,100 tons	0,070 tons	0,050 tons	0,100 tons	0,050 tons			
P4005.M005	M 5	0,075 tons	0,150 tons	0,075 tons	0,150 tons	0,100 tons	0,075 tons	0,150 tons	0,075 tons			
P4005.M006	M 6	0,100 tons	0,200 tons	0,100 tons	0,200 tons	0,140 tons	0,100 tons	0,200 tons	0,100 tons			
P4005.M008 & P4006.M008	M 8	0,30 tons	0,60 tons	0,30 tons	0,60 tons	0,40 tons	0,30 tons	0,60 tons	0,30 tons			
P4005.M010 & P4006.M010	M10	0,60 tons	1,20 tons	0,60 tons	1,20 tons	0,80 tons	0,60 tons	1,30 tons	0,60 tons			
P4005.M012 & P4006.M012	M12	1,00 tons	2,00 tons	1,00 tons	2,00 tons	1,40 tons	1,00 tons	2,10 tons	1,00 tons			
P4005.M014 & P4006.M014	M14	1,30 tons	2,60 tons	1,30 tons	2,60 tons	1,80 tons	1,30 tons	2,70 tons	1,30 tons			
P4005.M016 & P4006.M016	M16	1,60 tons	3,20 tons	1,60 tons	3,20 tons	2,20 tons	1,60 tons	3,40 tons	1,60 tons			
P4005.M018 & P4006.M018	M18	2,00 tons	4,00 tons	2,00 tons	4,00 tons	2,80 tons	2,00 tons	4,20 tons	2,00 tons			
P4005.M020 & P4006.M020	M20	2,50 tons	5,00 tons	2,50 tons	5,00 tons	3,50 tons	2,50 tons	5,30 tons	2,50 tons			
P4005.M022 & P4006.M022	M22	3,00 tons	6,00 tons	3,00 tons	6,00 tons	4,20 tons	3,00 tons	6,30 tons	3,00 tons			
P4005.M024	M24	4,00 tons	8,00 tons	4,00 tons	8,00 tons	5,60 tons	4,00 tons	8,40 tons	4,00 tons			
P4005.M027	M27	5,00 tons	10,00 tons	5,00 tons	10,00 tons	7,00 tons	5,00 tons	10,50 tons	5,00 tons			
P4005.M030	M30	6,30 tons	12,60 tons	6,30 tons	12,60 tons	8,8 tons	6,30 tons	13,20 tons	6,30 tons			
P4005.I031 & P4006.I031	(UNC 5/16"-18)	650 lbs	1,300 lbs	650 lbs	1,300 lbs	910 lbs	650 lbs	1,365 lbs	650 lbs			
P4005.I037 & P4006.I037	(UNC 3/8"-16)	1,200 lbs	2,400 lbs	1,200 lbs	2,400 lbs	1,680 lbs	1,200 lbs	2,520 lbs	1,200 lbs			
P4005.I050 & P4006.I050	(UNC 1/2"-13)	2,200 lbs	4,400 lbs	2,200 lbs	4,400 lbs	3,080 lbs	2,200 lbs	4,620 lbs	2,200 lbs			
P4005.I063 & P4006.I063	(UNC 5/8"-11)	3,800 lbs	7,600 lbs	3,800 lbs	7,600 lbs	5,320 lbs	3,800 lbs	7,980 lbs	3,800 lbs			
P4005.I075 & P4006.I075	(UNC 3/4"-10)	5,500 lbs	11,000 lbs	5,500 lbs	11,000 lbs	7,700 lbs	5,500 lbs	11,550 lbs	5,500 lbs			
P4005.I088 & P4006.I088	(UNC 7/8"-9)	6,600 lbs	13,200 lbs	6,600 lbs	13,200 lbs	9,240 lbs	6,600 lbs	13,860 lbs	6,600 lbs			
P4005.I100	(UNC 1"-8)	10,000 lbs	20,000 lbs	10,000 lbs	20,000 lbs	14,000 lbs	10,000 lbs	21,000 lbs	10,000 lbs			

ov-W63050-AP4005-T-W63054-AP4006-T-lifting-bolts-double-lifting-rings-rmh - Updated 19.01.2023

LIFTING PINS, LIFTING BOLTS & SWING BOLTS